

Kelly KLS8080I/IPS Motor Controller User's Manual

KLS72501-8080I	KLS72601-8080I	KLS72701-8080I
KLS96501-8080I	KLS96601-8080I	KLS12201-8080I
KLS12301-8080I	KLS14201-8080I	KLS14301-8080I
KLS14401-8080I		
KLS72501-8080IPS	KLS72601-8080IPS	KLS72701-8080IPS
KLS96501-8080IPS	KLS96601-8080IPS	KLS12201-8080IPS
KLS12301-8080IPS	KLS14201-8080IPS	KLS14301-8080IPS
KLS14401-8080IPS		

Rev.1.11
Dec.2017



Contents

Chapter 1	Introduction.....	2
1.1	Overview.....	2
Chapter 2	Features and Specifications.....	3
2.1	General functions.....	3
2.2	Features.....	4
2.3	Specifications.....	5
2.4	Name Regulation.....	5
Chapter 3	Wiring and Installation.....	6
3.1	Mounting the Controller.....	6
3.2	Connections.....	8
3.3	Installation Check List.....	13
Chapter 4	Programmable Parameters.....	14
4.1	Step 1.....	14
4.2	Step 2.....	19
4.3	Step 3.....	20
4.4	How to use Identification angle operation for KLS-8080I controller.....	22
4.5	How to use Identification angle operation for KLS-8080IPS controller.....	25
Chapter 5	Maintenance.....	31
5.1	Cleaning.....	32
5.2	Configuration.....	32
Table 1:	ERROR CODES.....	33
Contact Us:	35

Chapter 1 Introduction

1.1 Overview

This manual introduces the Kelly sinusoidal wave brushless BLDC motor controllers' features, their installation and their maintenance. Read the manual carefully and thoroughly before using the controller. If you have any questions, please contact the support center of Kelly Controls.

Kelly's programmable motor controllers provide efficient, smooth and quiet controls for electric motorcycles, golf carts and go-carts, as well as industrial motor control. It is mainly supposed to solve noise problems of BLDC motor driving application. KLS controller can not support sensorless brushless motor for now. Compared to the traditional trapezoidal waveform control technology, this technique based on sinusoidal wave driving technology to reduce the operation noise and 1/3 switching loss, which well meets the noise reduction and efficiency requirements in the application of DC brushless motor. It uses high power MOSFET's and, SVPWM and FOC to achieve efficiencies of up to 99% in most cases. A powerful microprocessor brings in comprehensive and precise control to the controllers. It also allows users to adjust parameters, conduct tests, and obtain diagnostic information quickly and easily. People can program the KLS controller on PC software and Android App. There is one more choice for customers to program KLS controller now. The APP software is based on Tablet with Android OS. Customers may add a Z-TEK USB to RS232 cable for programming KLS controller if they want to use Android Tablet.

Both PC software and Android APP can provide one screen to monitor the controller parameters. Sometimes people can use a small Android Tablet as display device.

KLS8080I/IPS is designed by opto-isolated technology. We specify 8-30V for power supply which must be isolated from main battery pack B+/B-. You may use an isolated DCDC converter or a separate 12V battery for power supply. KLS8080I is supposed to work with BLDC motor with hall sensors. KLS8080IPS can work with brushless motor with Sin/Cosin speed sensors.

KLS8080I/IPS controller included the fuse on the plastic case.

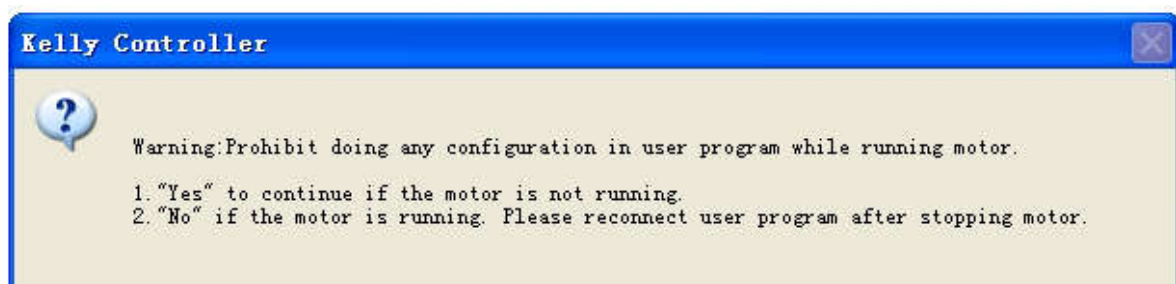

Anyway please try to do identification angle operation before running the motor.

And please don't try to connect the controller to user program while the motor is still running, let

alone change the setting in user program or Android App. That is to say, if you want to connect controller to user program or try to do programming, please stop the motor first.

This is the most important thing.

Chapter 2 Features and Specifications

2.1 General functions

- (1) Extended fault detection and protection. Customers can read the error code in PC software or Android Tablet also.
- (2) Monitoring battery voltage. It will stop driving if the battery voltage is too high and it will progressively cut back motor drive power as battery voltage drops until it cuts out altogether at the preset "Low Battery Voltage" setting.
- (3) Built-in current loop and over current protection.
- (4) Configurable motor temperature protection range.
- (5) Current cutback at low temperature and high temperature to protect battery and controller. The current begins to ramp down at 90°C case temperature, shutting down at 100°C.
- (6) The controller keeps monitoring battery recharging voltage during regen braking.
- (7) Maximum reverse speed and forward speed can be configured between 20% and 100% respectively and separately.
- (8) A 4pin connector to RS232 port and a Z-TEK USB to RS232 cable allows for configuration, programming and software upgrades using the tablet which must be based on Android OS now. People can do the same things on PC software by using a standard USB to RS232 cable instead.
- (9) Provision of a +5 volt and +12 volt output to supply various kinds of hall sensors.
- (10) 5 switch inputs which are activated by connection to 12V. Default to throttle switch, brake switch, reversing switch, forward switch and Boost switch.
- (11) 3 analog 0-5V inputs that default to throttle input, Brake analog input and motor temperature input
- (12) Copy signal of one of sensors.
- (13) Configurable boost switch. Enables the maximum output power achievable if the switch is turned on. The effect is the same as full throttle position even if you don't turn throttle at all.
- (14) 12V brake switch input used different port from motor temperature sensor. You can use both brake switch and motor temperature sensor functions at the same time on the latest version. Pin 25 is 12V brake switch input port. Pin1 is motor temperature sensor input port.
- (15) Optional joystick throttle. A bi-symmetrical 0-5V signal for both forward and reversing.
- (16) Configurable motor over-temperature detection and protection with the recommended thermistor KTY84-130/150 or KTY83-122.
- (17) 3 hall position sensor inputs. Open collector, pull up provided. Sin/Cosin Speed sensors inputs.

- (18) Brake analog regen mode. This regen mode doesn't need brake switch to support any more. Only available from software version 0106 or advanced version.
- (19) Enhanced regen brake function. A novel ABS technique provides powerful and smooth regen. The regen can happen at any speeds until zero speed.
- (20) Cruise control. Only can be activated in forward direction.
- (21) KLS-8080I/IPS can support Broadcast type CAN bus function. It is 250Kbps. By default, KLS-8080I/IPS controller includes CAN bus function.
- (22) Bluetooth function. Required a small Bluetooth converter which needs to be purchased in addition from our website. This small converter is only useful for KLS controller.
- (23) Can support three speed function on the latest version.

Caution! *The regen is not a safe function. Usually you may use the mechanical brake.*

2.2 Features

- 1) Intelligence with powerful microprocessor.
- 2) Synchronous rectification, ultra low drop, fast SVPWM and FOC to achieve very high efficiency.
- 3) Electronic reversing.
- 4) Voltage monitoring on 3 motor phases, bus, and power supply.
- 5) Voltage monitoring on voltage source 12V and 5V.
- 6) Current sense on all 3 motor phases.
- 7) Current control loop.
- 8) Hardware over current protection.
- 9) Hardware over voltage protection.
- 10) Configurable limit for motor current and battery current.
- 11) Low EMC.
- 12) Battery protection: current cutback, warning and shutdown at configurable high and low battery voltage.
- 13) Rugged aluminum housing for maximum heat dissipation and harsh environment.
- 14) Rugged high current terminals, and rugged aviation connectors for small signal.
- 15) Thermal protection: current cut back, warning and shutdown on high temperature.
- 16) Controller can do auto_ Identification angle for different Sine/Cosine Speed sensors. Can adjust the zero-crossing point and signal amplitude to match different Sine/Cosine speed sensors.
- 17) Configurable high pedal protection: the controller will not work if high throttle is detected at power on.
- 18) Current multiplication: Take less current from battery, output more current to motor.
- 19) Easy installation: 3-wire potentiometer will work.
- 20) Standard PC/Laptop computer to do programming. There is one more choice for customers to program KLS controller. Standard Tablet with Android OS to do programming. Need a Z-TEK USB TO RS232 cable for connecting the controller to App program in Tablet.
- 21) User program provided. Easy to use. No cost to customers.
- 22) Support motors with any number of poles.
- 23) Up to 70,000 electric RPM standard. (Electric RPM = mechanical RPM * motor pole

pairs;Motor pole pairs=Motor poles/2).

2.3 Specifications

- Frequency of Operation: 10KHz or 20kHz.
- Standby Battery Current: < 0.5mA.
- 5V or 12V Sensor Supply Current: 40mA.
- Controller supply voltage range: PWR, 8V to 30V for pin7 and pin6 which must be isolated from main battery pack B+/B-.
- Supply Current, PWR, 30mA Typical.
- Configurable battery voltage range, B+. Max operating range: 18V to 1.25*Nominal Voltage.
- Standard Throttle Input: 0-5 Volts(3-wire resistive pot), 1-4 Volts(hall active throttle).
- Throttle Input: 0-5 Volts. Can use 3-wire pot to produce 0-5V signal.
-
- Full Power Operating Temperature Range: 0°C to 70°C(MOSFET temperature).
- Operating Temperature Range: -40°C to 100°C (MOSFET temperature).
- Max Battery Current :Configurable.

2.4 Name Regulation

The name regulation of Kelly KLS motor controllers:

KLS 8080I/IPS

KLS:Kelly BLDC motor controller based on sinusoidal waveform.KLS8080I is supposed to work with brushless motor with three hall sensors while KLS8080IPS can work with Sin/Cosin speed sensors.There are +5V,Sin,Cosin and GND I/O ports for brushless motor with Sin/Cosin speed sensors.

I:KLS8080I is designed by opto-isolated technology.We specify 8-30V for power supply which must be isolated from main battery pack B+/B-.

Kelly KLS8080I/IPS Sinusoidal Brushless Motor Controller			
Model	60 seconds Current(Amp)	Continuous Current(Amp)	Voltage(Volt)
KLS72501-8080I/IPS	500	200	24-72
KLS72601-8080I/IPS	600	240	24-72
KLS72701-8080I/IPS	700	280	24-72
Model	30 seconds Current(Amp)	Continuous Current(Amp)	Voltage(Volt)
KLS96501-8080I/IPS	500	200	24-96
KLS96601-8080I/IPS	600	240	24-96
KLS12201-8080I/IPS	200	80	24-120
KLS12301-8080I/IPS	300	120	24-120

KLS14201-8080I/IPS	200	80	24-144
KLS14301-8080I/IPS	300	120	24-144
KLS14401-8080I/IPS	400	160	24-144

Chapter 3 Wiring and Installation

3.1 Mounting the Controller

The controller can be oriented in any position which should be as clean and dry as possible, and if necessary, shielded with a cover to protect it from water and contaminants.

To ensure full rated output power, the controller should be fastened to a clean, flat metal surface with four screws. Applying silicon grease or some other thermal conductive material to contact surface will enhance thermal performance.

Proper heat sinking and airflow are vital to achieve the full power capability of the controller. The case outline and mounting holes' dimensions are shown in Figure 1.

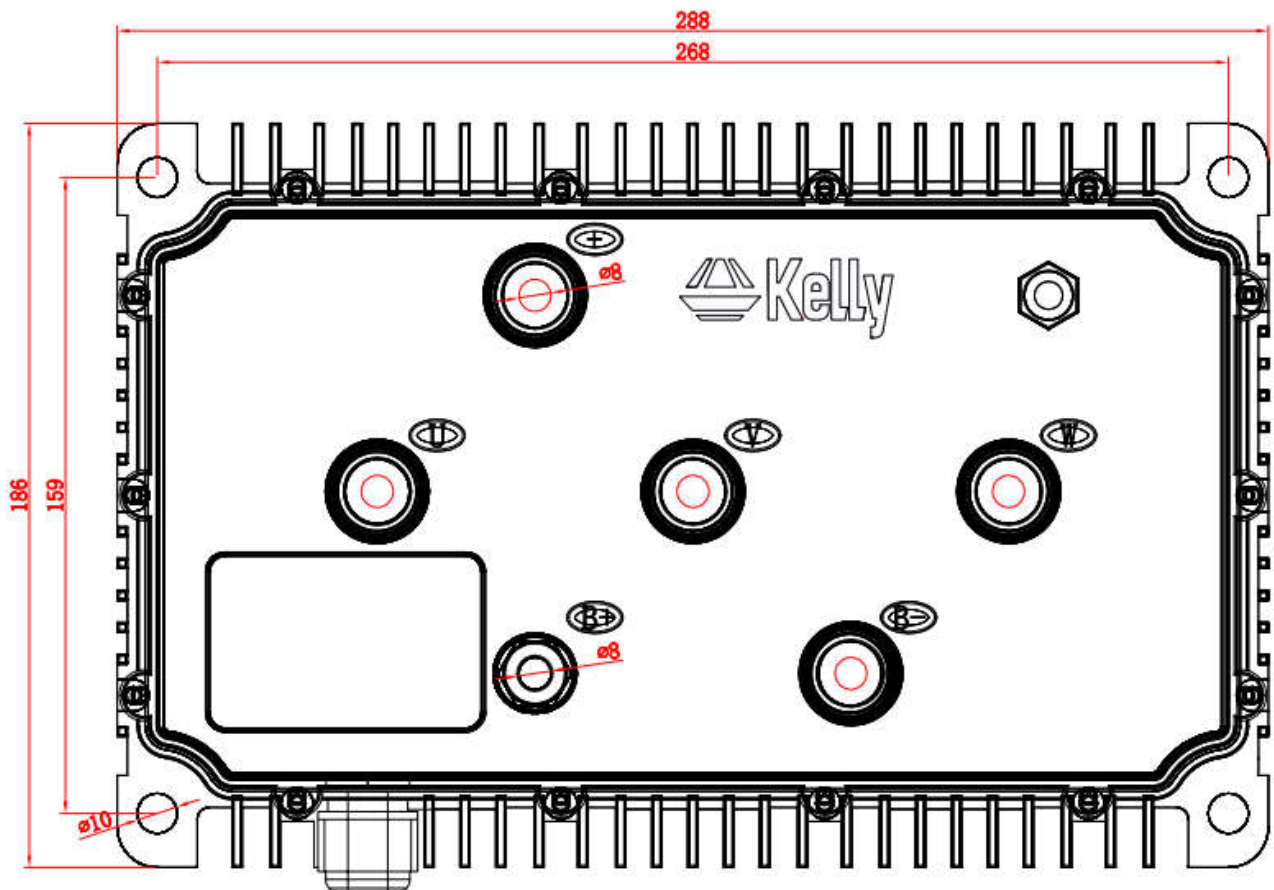

Figure

1:KLS72501-8080I/IPS,KLS12201-8080I/IPS,KLS12301-8080I/IPS,KLS14201-8080I/IPS,KLS14301-8080I/IPS mounting holes' dimensions (dimensions in millimeters)

Size:288mm*186mm(268mm*159mm)*68mm;+/B+/B-/U/V/W:M8

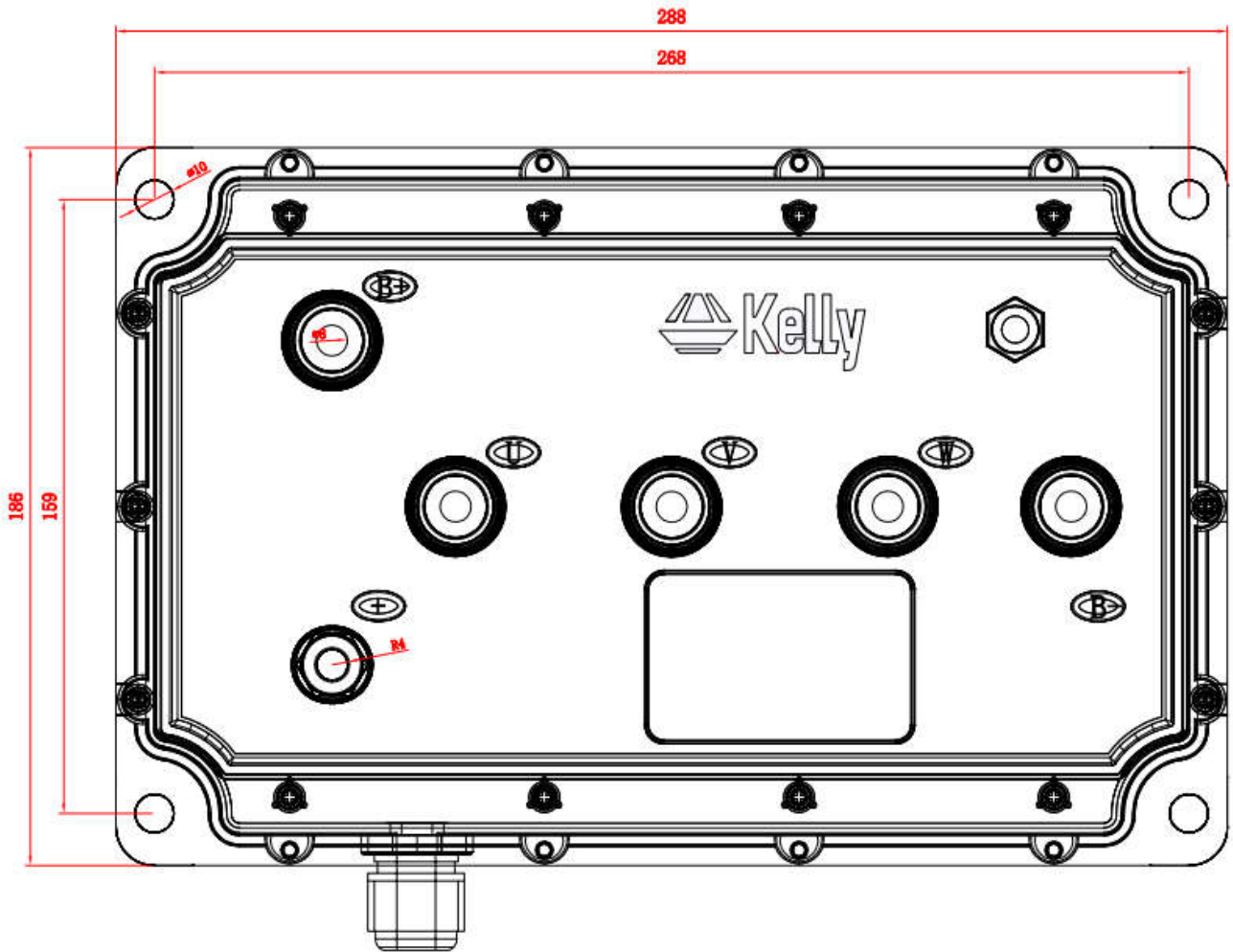
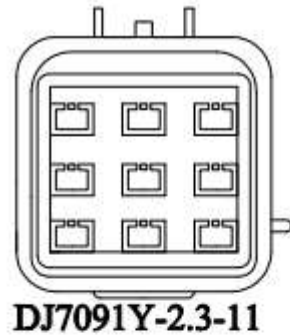

Figure2:KLS72601-8080/IPS,KLS72701-8080/IPS,KLS96501-8080/IPS,KLS96601-8080/IPS, KLS14401-8080/IPS mounting holes' dimensions (dimensions in millimeters)

Size:288mm*186mm(268mm*159mm)*81mm;+/B+/B-/U/V/W:M8

3.2 Connections

3.2.1 Pin definition of KLS8080I/IPS Controller



Orange REV-SW (14)	Black GND (6)	White FWD (12)
Red 12V (11)	Yellowish 12V Brake (25)	Blue ECO (22)
Greenish CAN_H (33)	Pink PWR (7)	Brownish CAN_L (34)



Gray Foot_SW (15)	Green Throttle (3)	
Black GND (20)	D-Gray Meter (8)	
Purple 5V (4)	Brown Brake_AN (2)	Red 12V (11)



Black GND (21)	Raddle Temp (1)	Purple 5V (5)
Yellow Hall A (18)	D-Green Hall B (17)	D-Blue Hall C (16)

1, The switch signal is valid to 12V on pin11.

2, 12V capacity is low. This 12V only can be used for LED or switch signals.

3, Boost and Brake analog regeneration mode used the same pin as pin2.

When Boost is disabled in the user program, the pin2 can be used as brake variable regen mode. When Boost is enabled, the brake analog regen mode is inactivated automatically. Both Boost and Brake variable regen mode can not be used at the same time.

Figure 2:KLS8080I/IPS waterproof connector

DJ7091Y-2.3-11 Pin Definition

- (14) REV_SW: Reverse switch input. Orange
- (6) RTN: Signal return or power supply return. Black
- (12) FWD: Forward switch or High speed switch White
- (11) 12V:12V Source Red
- (25) 12V brake switch. Yellowish
- (22) ECO: Low speed switch input Blue
- (33)CAN-H:Greenish(Optional function)
- (7) PWR: Controller power supply (input). Pink
- (34)CAN-L:Brownish(Optional function)

DJ7091Y-2.3-21 Pin Definition

- (15) Micro_SW: Throttle switch input. Gray
- (3) Throttle: Throttle analog input, 0-5V. Dark Green
- (20) RTN: Signal return. Black
- (8) Meter: Copy signal of hall sensors. Dark Gray
- (4) 5V: 5V supply output, <40mA. Purple
- (2) Brake_AN: Brake variable regen or Boost function. Brown

DJ7061Y-2.3-21 Pin Definition

- (21) RTN:Signal return. Black
- (1) Temp: Motor temperature sensor input. Raddle
- (5) 5V: 5V supply output,<40mA.Purple
- (18) Hall A: Hall phase A. Yellow 【This is Sine signal input on KLS8080IPS】
- (17) Hall B: Hall phase B. Dark Green 【This is Cosine signal input on KLS8080IPS】
- (16) Hall C: Hall phase C. Dark Blue 【There is no hall C signal input on KLS8080IPS】

Notes:

1. All RTN pins are internally connected.
2. Meter function is to copy either of hall sensors.
3. Switch to 12V is active. Open switch is inactive.

Caution:

- Do not apply power until you are certain the controller wiring is correct and has been double checked. Wiring faults will damage the controller.
- Ensure that the B- wiring is securely and properly connected before applying power.
- The preferred connection of the system contactor or circuit breaker is in series with the B+ line.
- All contactors or circuit breakers in the B+ line must have precharge resistors across their contacts. Lack of even one of these precharge resistors may severely damage the controller at switch-on.

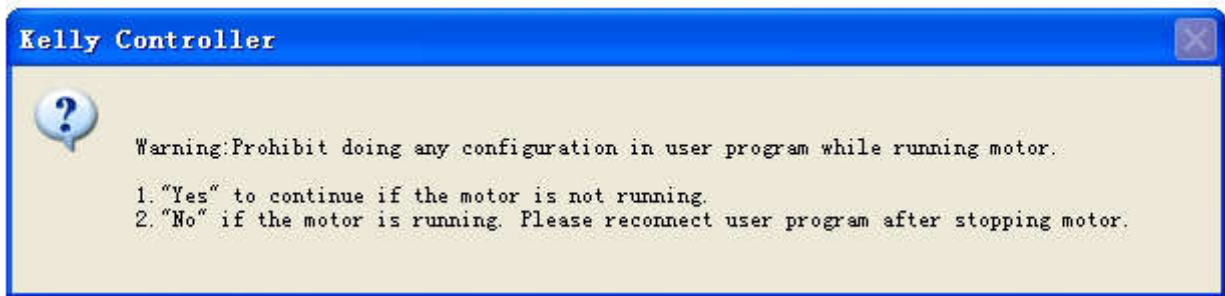

3.2.2 Standard Wiring of KLS8080I/IPS Controller

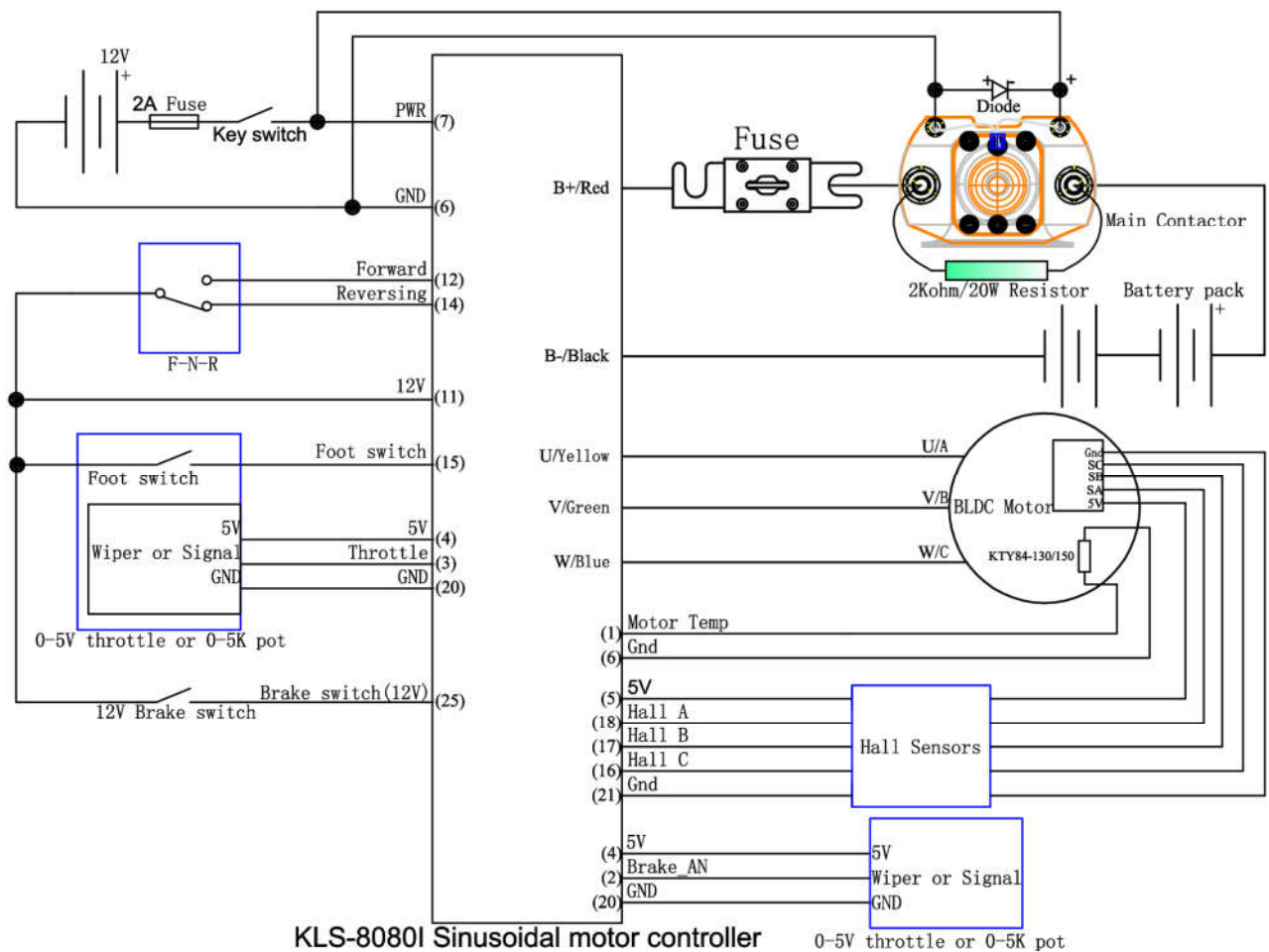

Figure 3: KLS8080I controller standard wiring

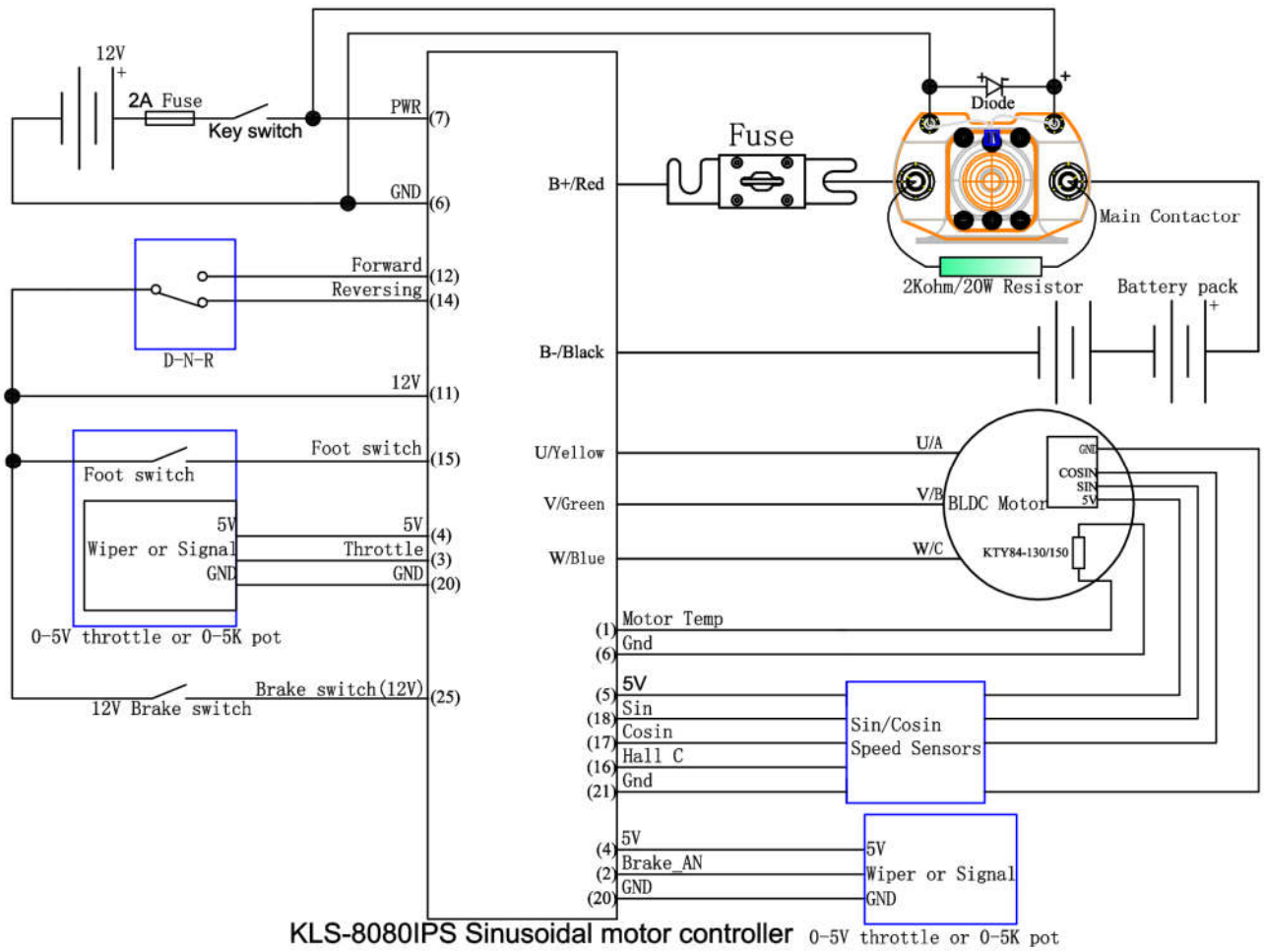

Figure 4: KLS8080IPS controller standard wiring

3.2.3 Optional wiring of KLS8080I/IPS controller

The 12V input signal of the pin supplies the second braking function of the controller.

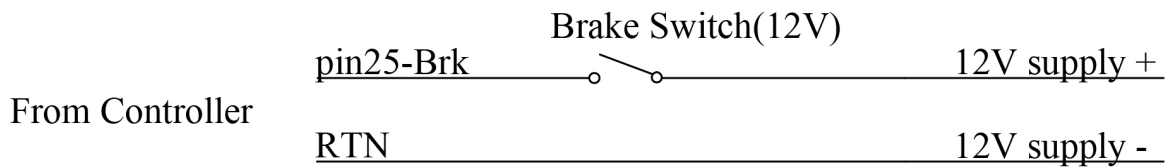

Figure 5: Wiring of brake switch(12V): 12V is provided by external source.

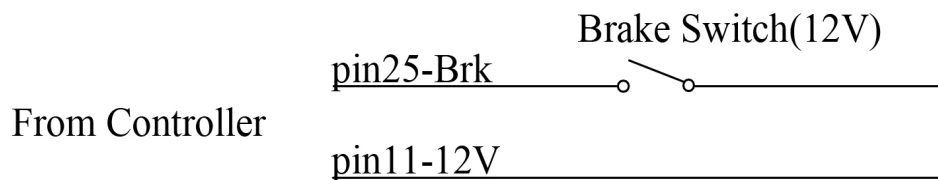

Figure 6: Wiring of brake switch(12V): 12V is provided by KLS8080I controller on pin11

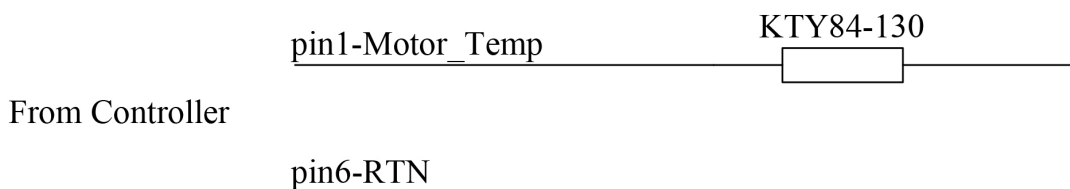

Figure 7: Wiring diagram for motor temperature sensor

NOTE:KLS controller can support KTY84-150, KTY84-130,KTY83-122 thermistors.

3.2.4 Communication Port

A 4pin connector to RS232 port is provided to communicate with host computer for calibration and configuration.

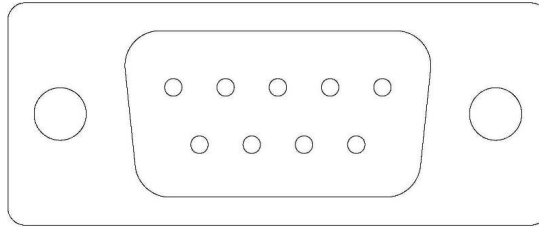

Figure 8: RS232 Interface on 4pin connector to RS232 converter

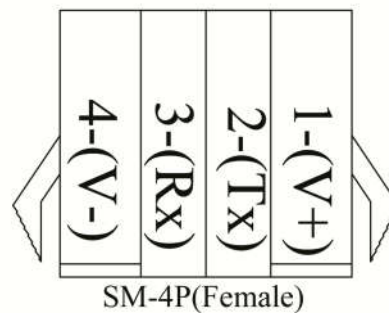

Figure 9: SM-4P connector for communication interface on KLS8080I controller

3.3 Installation Check List

Before operating the vehicle, complete the following checkout procedure. Use LED code as a reference as listed in Table 1.

Caution:

- Put the vehicle up on blocks to get the drive wheels off the ground before beginning these tests.
- Do not allow anyone to stand directly in front of or behind the vehicle during the checkout.
- Make sure the PWR switch and the brake is off
- Use well-insulated tools.
- Prohibit trying to connect the controller to user program while the motor is still running, let alone change the settings in the user program.

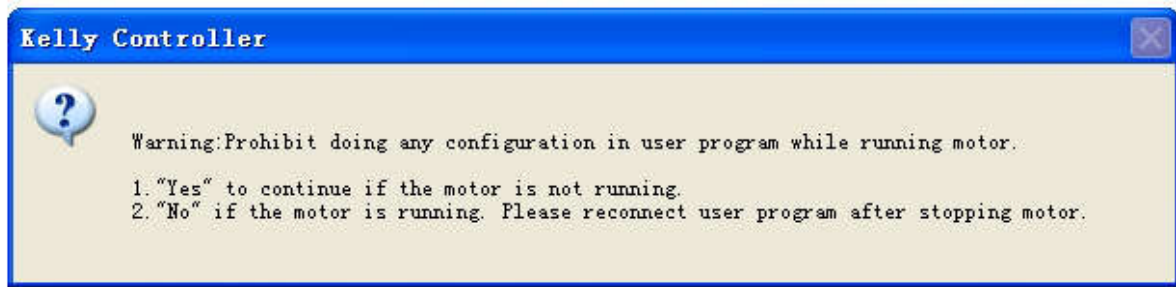

- Make sure the wire is connected correctly
- Turn the PWR switch on.
- The fault code will be detected automatically at restart.
- With the brake switch open, select a direction and operate the throttle. The motor should spin in the selected direction. Verify wiring or voltage and the fuse if it does not. The motor should run faster with increasing throttle. If not, refer to the Table 1 code, and correct the fault as determined by the fault code.
- Take the vehicle off the blocks and drive it in a clear area. It should have smooth acceleration and good power.

Chapter 4 Programmable Parameters

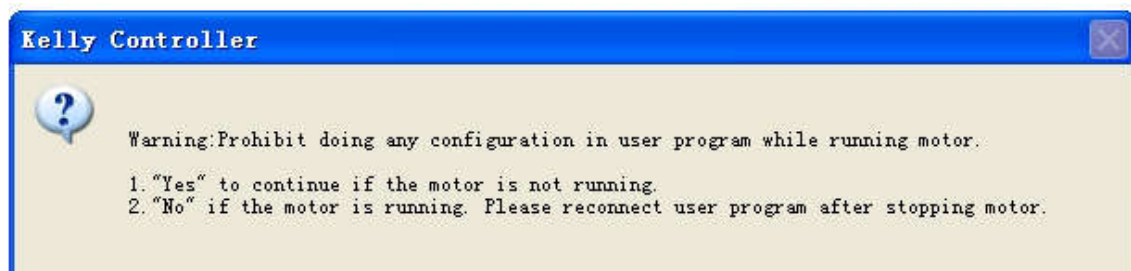

KLS Configuration program allow users to set parameters according to the vehicle actual working environment so as to be at its best.

The default parameters of the controller are not recommended for all applications. Make sure set the proper parameters before making any test to avoid danger.

Customers can do program on PC software or Android App. The Android Tablet is preferred. First of all, people need to do Identification angle function for KLS controller before running the motor. The controller needs to be connected to batteries, motor and throttle before Identification operation. That is to say, it is not enough to connect only power supply (PWR=pin7)

to batteries for Identification Angle operation.

Please download the instruction how to use Identification angle function from our website.
www.kellycontroller.com/support.php

4.1 Step 1

(1)Low Volt: The min voltage of reporting this fault - Range 18~180

Controller will not operate when battery voltage is near the value so as to protect battery.

Suggestion: Set according to the practical situation.By default,it is set at 18V.

(2)Over Volt: The max voltage of reporting this fault - Range 18~180

Controller will not operate when battery voltage is higher than the value so as to protect battery and controller.

Suggestion: Set according to the practical situation.

Here is the max voltage for each model.

72V controller:90V

96V controller:120V

120V controller:136V

144V controller:180V

Controller Rated voltage	Under Voltage Range (V)	Over Voltage Range(V)
72V	18~90	18~90
96V	18~120	18~120
120V	18~136	18~136
144V	18~180	18~180

Figure 4.1

(3)Current Percent: Phase Current Percent. Range: 20~100

Functional description: The max motor current is (The Value * Peak Current of the Controller).

Suggestion: Factory default is 100%.

(4)Battery Limit: Battery Limit Current, Limit the max value of Battery Current. Range: 20~100

Functional description: Set max battery current so as to protect battery. A lower value means a lower battery output current and better protective effect. But excessively low value will affect acceleration.

Suggestion: Factory default is 100%.

(5)Identification Angle: Please download the instruction to how to use Identification angle function from the website.

www.kellycontroller.com/support.php

If you can read 85 in Identification Angle item,that is to say,the system is stable and

normal. Please fill in 170 for Identification Angle item in user program. Then please click Write button in user program. Please wait a few seconds before restart the power supply. You will see some info on Monitor screen after power supply is reset. If you see Reset error on the Monitor screen, that is to say, the auto_Identification is finished. You can see 85 in the Identification Angle item again. And the controller will blink error code. This is normal. Please reset the power supply again. Then everything will be fine. The motor is ready to be driven by the KLS controller.
Range: 85 or 170, nothing else.

(6) TPS Low Err: Hall active pedal, if lower than the value, report the fault of TPS Type. Range: 0~20

(7) TPS High Err: Hall active pedal, if higher than the value, report the fault of TPS Type. Range: 80~100

As you may know, the output of hall throttle from Kelly is about from 0.86V to 4.2V.

Our controller will report 3.3 error code if the output of hall throttle is below 0.5V or above 4.5V by default.

The controller will think the hall throttle is shorted or damaged if the output is beyond the range from 0.5V to 4.5V.

You can adjust the threshold voltage below or above 0.5V. The controller will report the 3.3 code to protect the system according to different types of hall throttle.

Because there are many different hall throttle suppliers in the world. The initial output can not be always in the range of 0.5V to 4.5V.

But it doesn't make any differences if you choose 0-5V or 3-wire pot for the throttle type. That is to say, these two settings are only useful for hall active throttle or pedal when you chose throttle type at 2.

As the same goes, it is valid to adjust the high threshold voltage above 4.5V or below 4.5V.

Usually the hall output voltage is 4.2V Max. If you adjust it to lower value which is near 4.2V, it may trigger the error code in normal way.

(8) TPS Type: TPS Type, 1: 0-5V 3-wire 0-5K pot, 5K is normal, 2K-20K can be used; 2: Hall active throttle or pedal. Range: 1~2

(9) TPS Dead Low: TPS Dead Zone Low. Range: 5~40

Functional description: Set throttle effective starting point

Suggestion: Set according to the practical situation, factory default is $20\% \times 5V = 1.0V$.

(10) TPS Dead High: TPS Dead Zone High. Range: 60~95

Functional description: Set throttle effective ending point

Suggestion: Set according to the practical situation, factory default is $80\% \times 5V = 4.0V$.

(11) Brake sensor type: Brake sensor type for brake variable regen mode:

1: 0-5V 3-wire 0-5K pot, 5K is normal, 2K-20K can be used; 2: Hall active throttle or pedal. Range:

1~2

(12)Brake sensor Dead Low: Brake sensor Dead Zone Low. Range: 5~40

Functional description: Set throttle effective starting point

Suggestion: Set according to the practical situation, factory default is $20\% * 5V = 1.0V$.

(13)Brake sensor Dead High: Brake sensor Dead Zone High. Range: 60~95

Functional description: Set throttle effective ending point

Suggestion: Set according to the practical situation, factory default is $80\% * 5V = 4.0V$.

(14)Max output Fre: Max output frequency. Unit:Hz

Functional description:It will affect the top speed of the motor.

Suggestion: Set according to the practical situation, factory default is 1000Hz.Please don't set it 1000Hz above.

(15)Max Speed: Max Speed [rpm]. Range: 0~15000 By default,it is set at 4000.Software version 0109 can support 15000RPM settings in user program.

(16)Max Fwd Speed %: The forward speed of the percentage of maximum speed. Range: 20~100 By default,it is set at 100%

(17)Max Rev Speed %: The reverse speed of the percentage of maximum speed. Range: 20~100 By default,it is set at 100%

Midspeed Forw speed, Midspeed Rev speed, Lowspeed Forw speed and Lowspeed Rev speed.Range: 20~100 By default,it is set at 100%.Both F-N-R control and three speed function used the same pin12.Needless to say,we can not use both functions at the same time.Three Gears switch is supposed to enable F-N-R control.When this item is disabled,we can use three speed function,vice versa.

Pin22 is low speed switch input port while Pin12 is high speed switch input port.When both pin22 and pin12 are disconnected from pin11,the controller is driving with medium speed mode.

Three speed:This item is used to enable or disable three speed function.By default,it is at 0
0:Three speed function is disabled.1:Two speed function.2:Three speed function is enabled.

(18)PWM Frequency: Frequency of PWM operation. Unit:KHz

Functional description:20KHz is better for hub motor with strict quiet control.

Suggestion: Set according to the practical situation, factory default is 20KHz.Please don't set it 20KHz above.

Value Range:10KHz or 20KHz

(19)Start-up H-Pedal:

Value range: Enable and Disable

Functional description: If enabled, the controller will detect the current pedal status at power up. If throttle got effective output, the controller will report fault and not operate.

Suggestion: Set according to the practical situation, factory default is Enable.

(20)Brake H-Pedal:Releasing Brake High Pedal Disable

Value range: Enable and Disable

Functional description: If enabled, the controller will detect the current pedal status when release the brake. If throttle got effective output, the controller will report fault and not operate.

Suggestion: Set according to the practical situation, factory default is Disable.

(21)NTL H-Pedal:Neutral position High Pedal Disable.Only useful when Three gears switch function is enabled.

If enable,the controller will detect the current pedal position or signal When the switch is in neutral poistion.

If the throttle got effective output signal,the controller will not operate and report fault code.

Suggestion: Set according to the practical situation, factory default is Disable.

(22)Joystick function:

If enable,the controller can drive the motor on two directions without using any reversing switch. Just one single throttle can drive the motor on forward and reversing direction.

The stick shift throttle firmware can be called wig-wag or joystick operation.It is only a software function.Usually It is useful for electric boat project.You still can use the common 0-5K pot or 0-5V throttle for the controller.If you don't choose the joystick,you operated the throttle in this way.The motor speed will increase when the throttle is from 0V to 5V.

If you enable joystick for this controller in user program,you will start the motor from 2.5V position.2.6V to 5V is forward.2.4V to 0V is backward.

2.4V to 2.6V is the throttle dead zone.Customers can adjust the throttle dead zone in user program also.

Please note the common throttle will spring back to original position if you release the throttle.

Suggestion:factory default is Disable.

(23)Three Gears switch:It is used for function of F-N-R control.

Please check the wiring diagram in the manual for F-N-R control.

Suggestion: Set according to the practical situation, factory default is Disable.

(20-A)Three Gears Switch

Value range: Enable and Disable

Functional description: If enabled, the Forward switch will be activated. Please see figure 4.1.

Suggestion: Set according to the practical situation, factory default is Disable.

(20-B)Foot Switch

Value range: Enable and Disable

Functional description: If enabled,the foot switch will be activated.The controller will not accept the throttle signal if the foot switch is turned off. Please see figure 4.1.

Suggestion: Set according to the practical situation, factory default is Disable.

Configuration		Pin Status			Running Status
Forward Switch	Foot Switch	FWD_SW (12)	REV_SW (14)	Foot (15)	
Enable	Disable	OFF	OFF	x	Neutral
		OFF	ON	x	Reverse
		ON	OFF	x	Forward
		ON	ON	x	Neutral
Disable	Enable	x	OFF	OFF	Can't operate
		x	ON	OFF	Can't operate
		x	ON	ON	Reverse
		x	OFF	ON	Forward
Disable	Disable	x	OFF	x	Forward
		x	ON	x	Reverse

Note: X means can be on or off

Figure 4.2

(24)Boost:If enabled,the controller will output max power for a while.

Boost function is just full throttle position when you turn on boost switch even if the throttle is not operated at all.

The boost function is still based on limiting of the motor current and battery current settings in user program.

If disabled,the controller can provide brake sensor regen mode on the same pin as pin2.In simple,boost and brake analog regen used the same pin as pin2.

Suggestion: Set according to the practical situation, factory default is Disable.So the default function is brake variable regen mode.

(25)Foot switch:It is used for microswitch.If enabled,the controller will only accept the throttle signal after received the valid foot switch signal.

If there is no foot switch signal,the controller will ignore the throttle signal.

Suggestion: Set according to the practical situation, factory default is Disable.

(26)Cruise Control:Value range: Enable and Disable

If enable,if you hold throttle at certain position about 5 seconds,the controller will get into Cruise control.The Cruise function can not be activated in reversing direction.If the motor speed is below 500RPM,the Cruise control can not be activated.

Release throttle and turn the throttle again or turn on the brake switch will make the Cruise control quit.

Suggestion:factory default is Disable.

(27)Anti-Slip:

If enabled,the controller will try to prevent the vehicle rolling back on downhill faster and faster.If the ratio of gearbox is high,it can try to help the motor stop on the downhill.But usually this

function only helps motor stop rolling back too fast.

Suggestion:factory default is Disable.

(28)Change Direction:

If the direction is not what you expected after finish the Identification angle operation,please just choose Change Direction item.

Please click Write button to activate Change Direction function.The motor direction will be what you expected after the power supply is reset.

Suggestion:factory default is Disable.

4.2 Step 2

(1)Motor Nominal Curr:When the controller is doing identification angle operation without load on the motor shaft,there is a current requirement for identification operation.If the motor rated power is very high,please increase this parameter to a higher value.Otherwise please keep it at 80 by default.If the motor power is very low such as hundreds of watts,please reduce this parameter to lower value to match the low power motor for identification angle operation.

(2)Motor Poles: Motor Poles, The pair pole number*2. Range: 2~128

Suggestion: Set according to the real motor poles on the nameplate of the motor, factory default is at 8.

(3)Speed Sensor Type: Speed Sensor Type, 2:Hal, 3:Resolver, 4:Line Hall. Range: 2~4

Different sensors type.By default,it is set at 2

If you have a motor with 5V,Sin/Cosin,GND speed sensors,please choose it at 4.And please inquire the KLS-8080IPS model before ordering.

(4)Resolver Poles: Resolver Poles, The pair pole number*2. Range: 2~32

It is only used for the Resolver sensor type.

(5)Motor Temp Sensor: Motor Temp Sensor, 0: None,1:KTY84-130 or 150,2:KTY83-122.Range 0-2

High Temp Cut Out ° C: Motor High Temp Cut Out, nominal value 130° C. Range: 60~170

Resume ° C: Motor High Temp Resume Temp, nominal value 110° C.The controller will resume work when the motor temp is at 110 degrees inside. Range: 60~170

(6)Line Hall Zero:It is only useful when the speed sensor is at 4.

Zero-Crossing point of Sine/Cosine linear hall sensors output signal.Usually the Sine/Cosine speed sensor supplier provided sensors with 2.5V or 3.0V zero-crossing point.

You can change it back between 2.5V and 3.0V if the motor can not run.

Suggestion: Set according to the practical situation, factory default is 613(3.0V) for Mars 1114/1115/1302/1304 from Motenergy company.

Value Range:0-1023 maps 0-5V

(7)Line Hall Amplitude:The position signal based on Zero-crossing point.It is only useful when the speed sensor is at 4.

For example,if the Line hall Amplitude is 1.1V,the signal output of Sine/Cosine sensors is from 1.9V to 4.1V.(3-1.1=1.9V;3+1.1V=4.1V)

Value Range:0-1023 maps 0-5V

(8)Line Hall High Err:It is only useful when the speed sensor is at 4.

If the signal output of Sine/Cosine speed sensor is above this setting,the controller will report hall error.Please adjust Line Hall High Err to a higher value to eliminate this error.

Value Range:0-1023 maps 0-5V

(9)Line Hall Low Err:It is only useful when the speed sensor is at 4.

If the signal output of Sine/Cosine speed sensor is below this setting,the controller will report hall error also.Please adjust Line Hall Low Err to a lower value to eliminate this error.

Value Range:0-1023 maps 0-5V

4.3 Step 3

(1)RLS_TPS Brk %: RLS TPS Braking Percent, the percent of Releasing Pedal BRK in max braking. Range: 0~50

This is used to adjust the regen current of releasing throttle regen mode type.The regen will happen as long as the throttle is released completely.

Factory set is 0

(2)NTL Brk %: NTL Braking Percent, the percent of Neutral Braking in max braking. Range: 0~50

Only useful when you enable Three gears switch in user program.

The regen will happen when you turn F-N-R switch from Forward or backward to Neutral position.

Factory set is 0

(3)Accel Time: Accel Time, the time of TPS Torque from 0 to max, accuracy 0.1s, 5 is equal to 0.5s. Range: 1~250

Factory set is 10

(4)Accel Rls Time: Accel Release Time, the time of TPS Torque from max to 0, accuracy 0.1s.

Range: 1~250

Factory set is 1

(5)Brake Time: Brake Time, the time of Brake Torque from 0 to max, accuracy 0.1s. Range: 1~250

Factory set is 15

(6)Brake RIs Time: Brake Release Time, the time of Brake Torque from max to 0, accuracy 0.1s.
Range: 1~250
Factory set is 1

(7)BRK_SW Brk %: BRK_SW Braking Percent, the percent of BRK_SW in max braking. Range:
0~50
The brake switch regen mode.You have to turn on the brake switch after the throttle is released for the regen to occur.
Factory set is 10

(8)BRK_AD Brk%:It is used to adjust the max regen percentage of brake variable regen mode.
This regen mode doesn't need brake switch to support any more for KLS controller.

(9)Torque Speed KP: Speed Percent Kp in Torque Mode. Range: 0~10000 Factory set is 3000
Torque Speed KI: Speed Integral Ki in Torque Mode. Range: 0~500 Factory set is 80
Speed Err Limit: Speed Error Limit in Torque Mode. Range: 50~4000 Factory set is 1000
These three parameters are used for PID adjustment.
If you think the acceleration performance is very very strong,please adjust them to a lower value respectively.

(10)Change Dir brake:Value range: Enable and Disable
It is only useful when you Enable the joystick function.
If you want to get swift direction changing by using joystick function,you may enable Change Dir brake item in user program.
It will help the motor change the direction of motor quickly after you shift throttle from 0V to 5V,or from 5V to 0V.
Suggestion:factory default is Disable.

(11)Compensation Per%
Tried to increase the current usage during Anti-Slip operation.

(12)IVT BRK MAX and IVT BRK MIN:These two items are only useful when Joystick function is enabled in the user program.When you want to use Change Dir Brake to reduce the delay time when you shift the direction under joystick operation,there is a RPM limitation to use Change Dir Brake function which is only activated when the motor RPM is between IVT BRK MIN and IVT BRK MAX.
Suggestion:factory default is Disable.

(13)Torque Speed Kp:3000
Torque Speed Ki:80
Speed Err Limit:1000

These parameters are used for PID adjustment. If the acceleration is too aggressive, please reduce these three parameters at the same time, vice versa. Please change the Torque Speed Kp every 1000 units, Torque speed Ki every 100 units and Speed Err limit every 500 units.

Note: Thermistor is optional. Default to KTY84-130/150 or KTY83-122

When controller temp item shows 246 in monitor screen of user program, it is normal. This item is only useful for internal calculation for MCU. 246 is about 11 degrees in environment.

4.4 How to use Identification angle operation for KLS-8080I controller

We must do Identification angle operation before running motor for all KLS controllers. The Identification angle operation can be done in PC program or Android App (Tablet or Cell Phone).

KLS-8080I controller is designed for BLDC motor with three hall sensors. By default, the speed sensor type is set at 2 from factory setting for KLS-8080I controller.

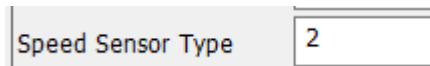

1, Please hook up the controller for identification angle operation according to the wiring diagram below. Please make sure there is no load on the motor shaft before starting the programming. The KLS-8080I is designed by opto-isolated technology. We specify 8-30V for power supply pin7 vs pin6 which must be isolated from main battery pack B+/B-. Usually customers can use 12V car battery or 12V Isolated type DCDC converter for this purpose.

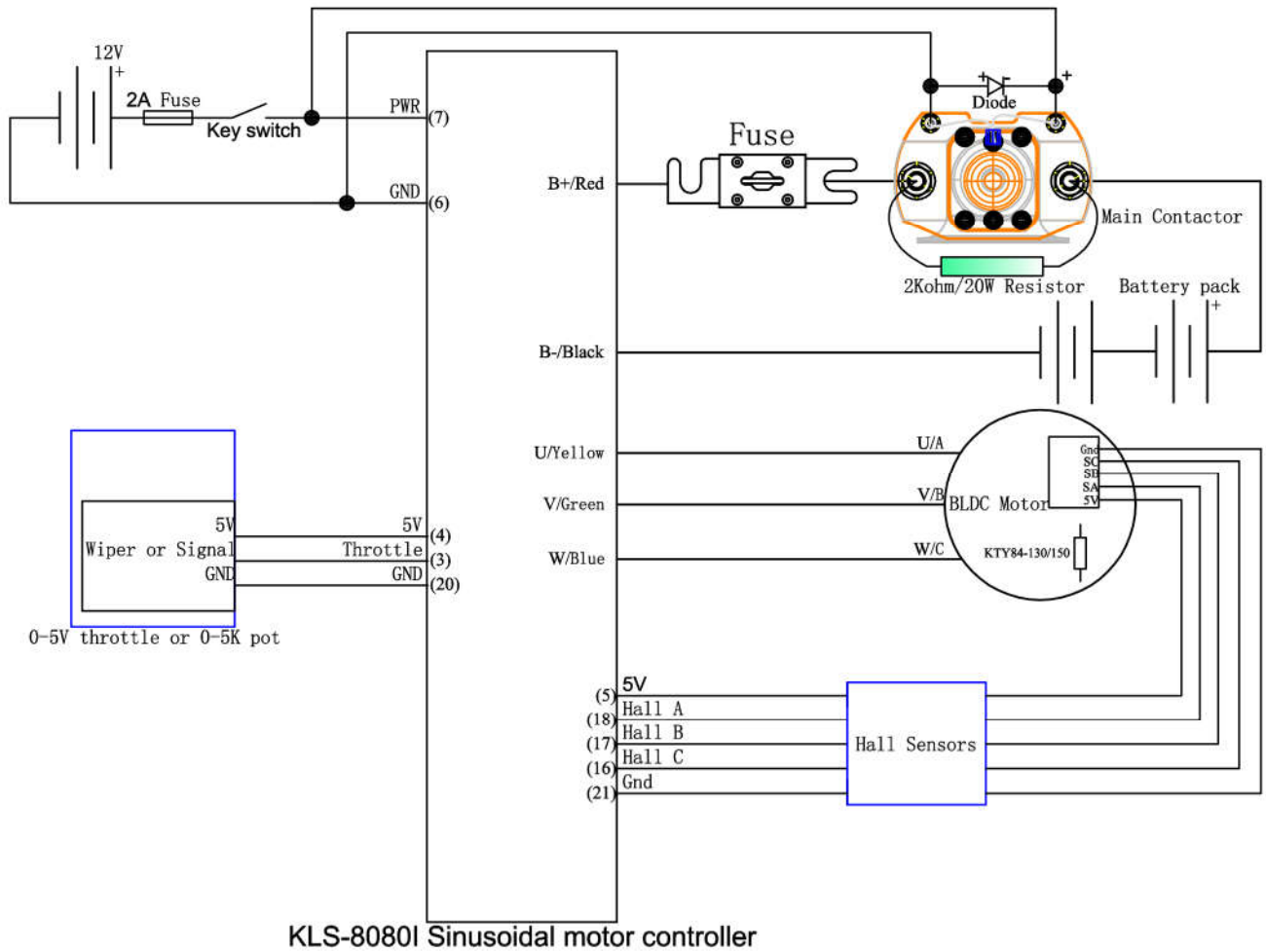

2, Please connect the controller to user program by using an USB to RS232 cable and SM-4A DB9(RS232) Converter.

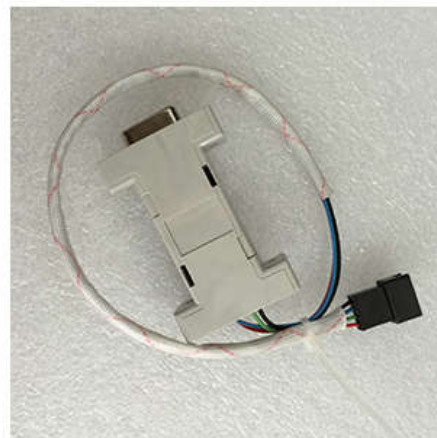

Customers also can use a Z-TEK USB to RS232 cable and SM-4A DB9(RS232) Converter to connect the controller to an Android Tablet.



The third option is customers can buy our Bluetooth converter to connect the controller to Android Phone. We don't have to use SM-4A to DB9(RS232) converter any more when you use Bluetooth converter for programming the controller.

3, Please download the controller user program from our website for free.

www.kellycontroller.com/support.php

Please install the user program in your computer, Tablet or Phone.

4, Please turn on the key switch so that the controller can get power supply from B+/B- and Pin7/Pin6. Please try to open the user program in your computer or other devices. Then you may try to click Read button in user program or App. You will see the first picture of user program.

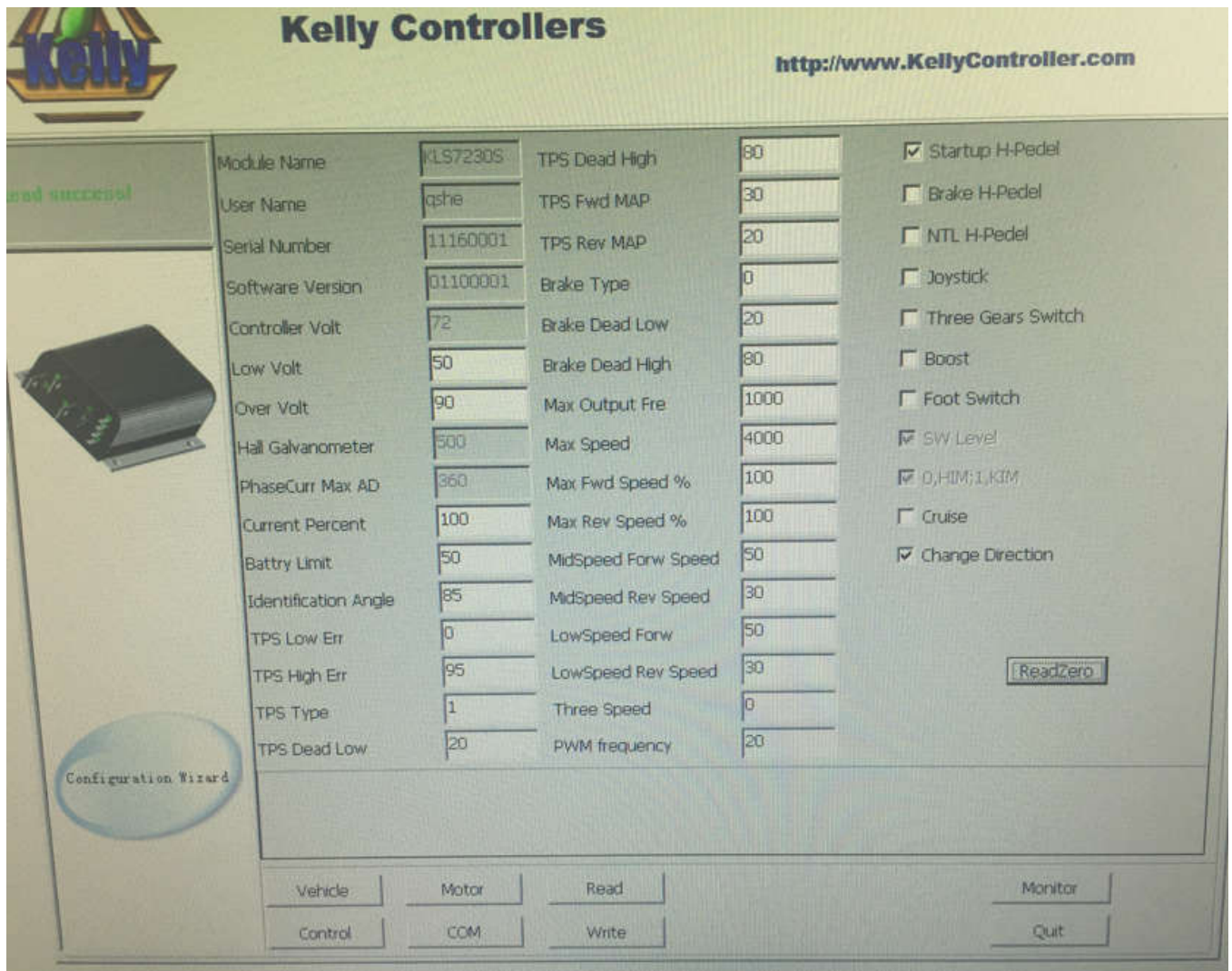

Please check whether the Identification Angle item is at 85 or not. It is correct if identification angle item is at 85.

5, Please fill 170 in the identification angle item. And please click the write button. The user program will give a pop-up window which show the Write operation is successful. Please quit from the user program. Please turn off the power supply.

6, Please turn on the power supply after the power supply is off for a few seconds. The motor shaft will try to run on directions randomly. It is normal because the controller is doing Identification angle operation.

7, Please wait about 2-3 minutes.

8, If the identification angle operation is finished, the motor will stop completely. Please try to reset the power and try to connect the controller to user program or APP again. And you will see reset error message in the monitor screen of user program.

9, Please turn off the power supply again. Please wait about a few seconds to turn on the power supply one more time.

10, Please try to connect the controller to user program again. You will see 85 in the identification angle item. That is to say, the controller identification angle operation is successful. You can use the KLS-8080I controller to drive the motor now.

11,As long as it is not reset error code,the value in identification angle will not go back to 85.The value is always at 170.That is to say,the controller is still in the processing of identification operation.

12,Please don't try to write 85 in the identification angle or reset the power supply if you don't see any error codes.

13,If the constant beep sound lasts above 5 minters and there are other error codes such as Identify error,hall err etc,please return to the first picture of user program.Please write 85 instead in identification angle by manual.

If there are no any error codes,you can not write it back to 85 by manual.Please wait longer time until the error codes occur.

Please don't keep 170 in the identification angle item when you want to turn off the power supply.

Otherwise the controller will try to keep doing identification operation all the time as long as you turn on power supply again.

When the error codes occur,please quit from user program.Please try again from step 6.

14,Please don't keep 170 in identification angle item before power supply is turned on after the identification operation is successful.

15,If the direction of the motor is not what you expected,please don't try to do Identification angle operation again.You just need to enable Change Direction item in the first picture of user program.Please click Write Button and reset the power supply to activate the setting.Then the motor will run on the expected direction.

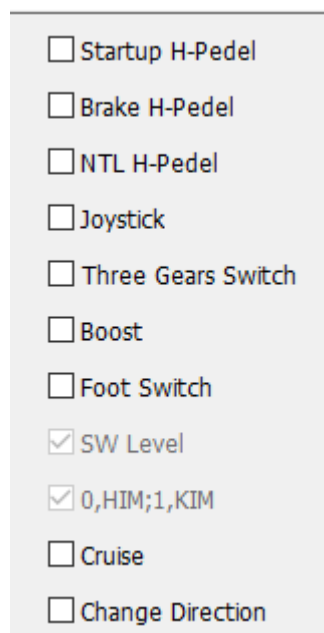

A screenshot of a control panel with a light gray background. It contains a list of settings, each with a checkbox. The settings are: Startup H-Pedel, Brake H-Pedel, NTL H-Pedel, Joystick, Three Gears Switch, Boost, Foot Switch, SW Level, 0,HIM;1,KIM, Cruise, and Change Direction. The checkboxes for SW Level and 0,HIM;1,KIM are checked, while all others are unchecked.

<input type="checkbox"/>	Startup H-Pedel
<input type="checkbox"/>	Brake H-Pedel
<input type="checkbox"/>	NTL H-Pedel
<input type="checkbox"/>	Joystick
<input type="checkbox"/>	Three Gears Switch
<input type="checkbox"/>	Boost
<input type="checkbox"/>	Foot Switch
<input checked="" type="checkbox"/>	SW Level
<input checked="" type="checkbox"/>	0,HIM;1,KIM
<input type="checkbox"/>	Cruise
<input type="checkbox"/>	Change Direction

4.5 How to use Identification angle operation for KLS-8080IPS controller

We must do Identification angle operation before running motor for all KLS controllers.The

Identification angle operation can be done in PC program or Android App(Tablet or Cell Phone).

KLS-8080IPS controller is designed for BLDC or PMSM motor with Sin/Cosin sensors.By default,the speed sensor type is set at 4 from factory setting for KLS-8080IPS controller.

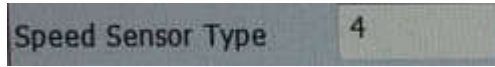

1,Please hook up the controller for identification angle operation according to the wiring diagram below.Please make sure there is no load on the motor shaft before starting the programming.The KLS-8080IPS is designed by opto-isolated technology.We specify 8-30V for power supply pin7 vs pin6 which must be isolated from main battery pack B+/B-.Usually customers can use 12V car battery or 12V Isolated type DCDC converter for this purpose.

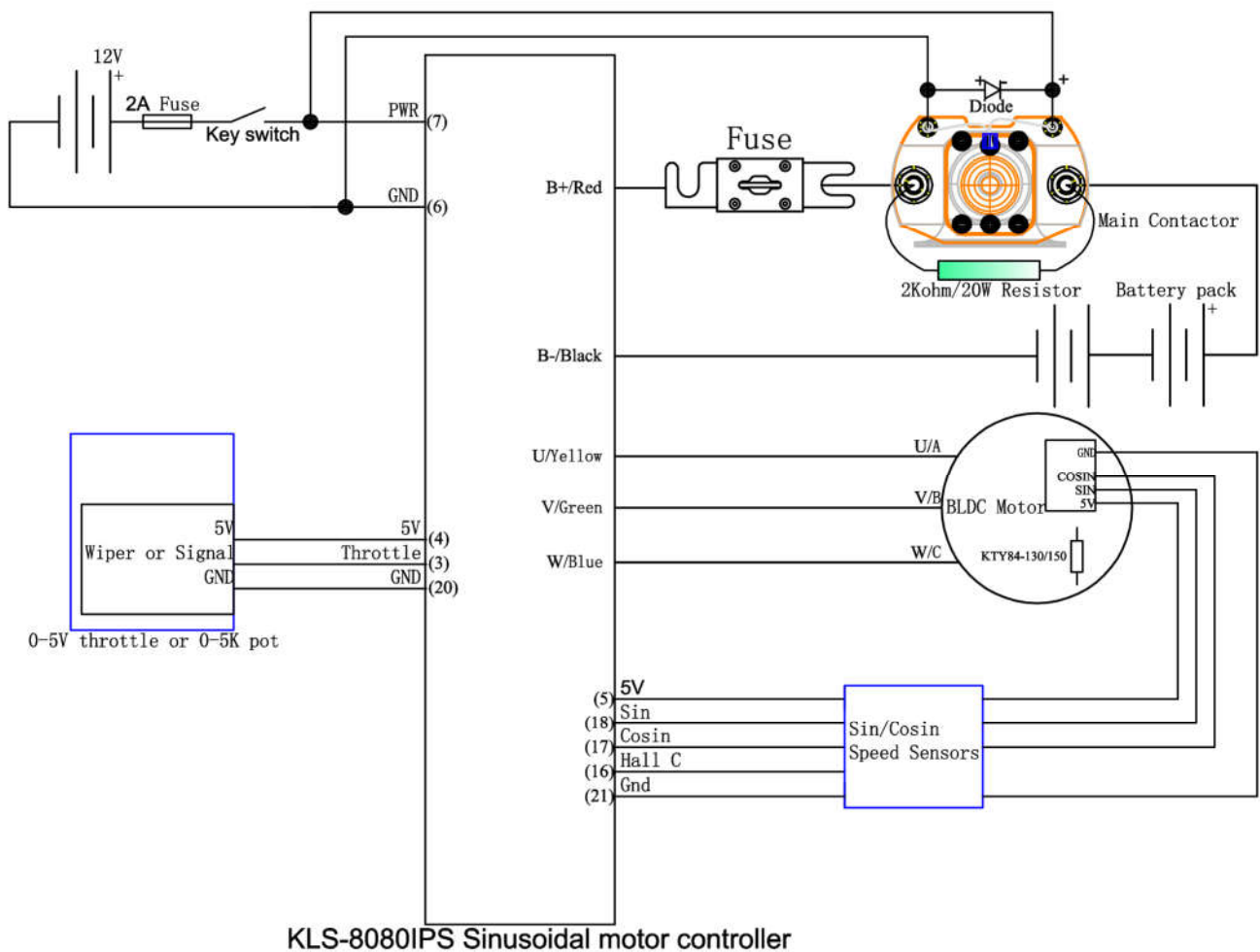

2,Please connect the controller to user program by using an USB to RS232 cable and SM-4A DB9(RS232) Converter.

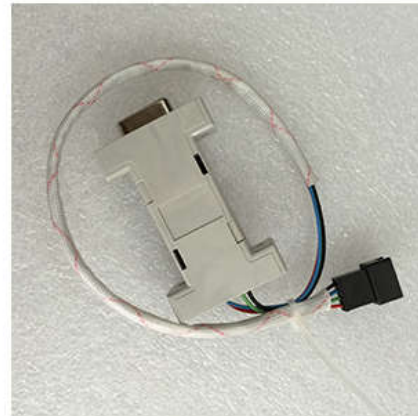

Customers also can use a Z-TEK USB to RS232 cable and SM-4A DB9(RS232) Converter to connect the controller to an Android Tablet.



The third option is customers can buy our Bluetooth converter to connect the controller to Android Phone. We don't have to use SM-4A to DB9(RS232) converter any more when you use Bluetooth converter for programming the controller.

3, Please download the controller user program from our website for free.

www.kellycontroller.com/support.php

Please install the user program in your computer, Tablet or Phone.

4.1, Please turn on the key switch so that the controller can get power supply from B+/B- and Pin7/Pin6. Please try to open the user program in your computer or other devices. Then you may try to click Read button in user program or App. You will see the first picture of user program.

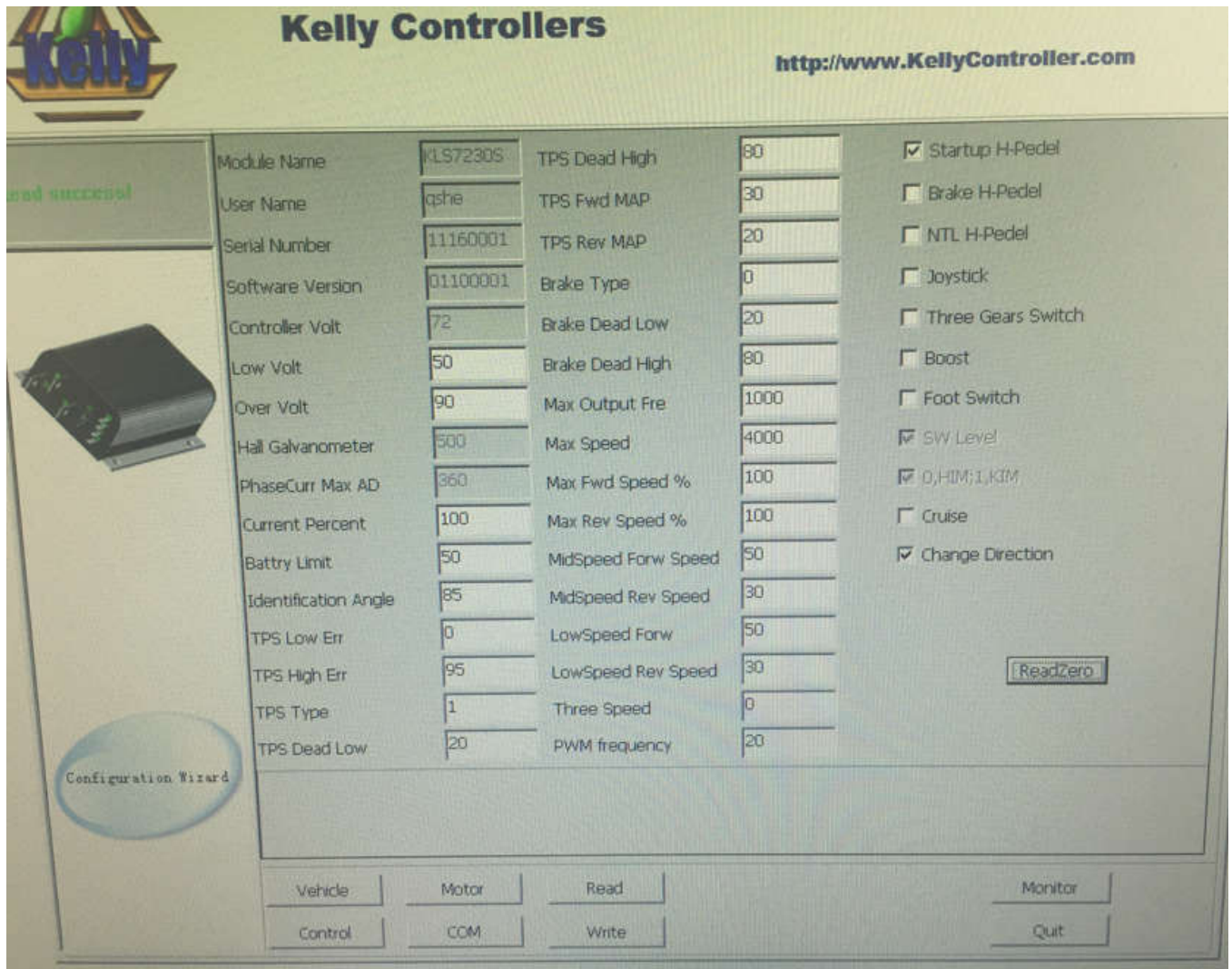

Please check whether the Identification Angle item is at 85 or not. It is correct if identification angle item is at 85.

4.2, Because this is a KLS-8080IPS controller based on Sin/Cosin speed sensor. We need to configure the correct parameters for Sin/Cosin speed sensor settings. Most of PMSM motor with Sin/Cosin speed sensor is based on RLS Encoder sensor. Anyway please check the data of Sin/Cosin sensor first. For example, we usually use RMB29AC Sin/Cosin speed sensor. Please check the features below.

RLS ENCODER SPECS

RMB29AC – Analogue sinusoidal

Power supply	$V_{dd} = 5\text{ V} \pm 5\%$
Resolution	one sine/cosine wave per revolution
Power consumption	13 mA
Sin/Cos outputs	Signal amplitude: $1.1\text{ V} \pm 0.2\text{ V}$
Operating temperature	-40 °C to +105 °C (limited by connector) All other components used are specified for operation from -40 °C to +125 °C.
Maximum speed	60,000 rpm
Accuracy*	$\pm 0.7^\circ$
Hysteresis	0.45°

* Worst case within operational parameters including magnet position and temperature.

Timing diagram

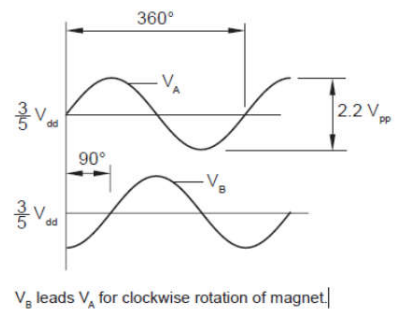

Usually we just need to configure two parameters in user program according to the specification of Sin/Cosin speed sensor. Please click Motor button in the user program.

Line hall zero: The line hall zero point is at $3V_{dd}/5 = 3 \times 5\text{V}/5 = 3.0\text{V}$. So we need to fill $3 \times 1023/5 = 613.8 = 614$ for Line hall zero parameter instead of 508 in the user program.

Line hall amplitude: The document showed the Amplitude is $1.1\text{V} \pm 0.2\text{V}$. We think the amplitude is 1.1V for now. So we need to fill $1.1 \times 1023/5 = 225$ for line hall amplitude instead of 410 in the user program.

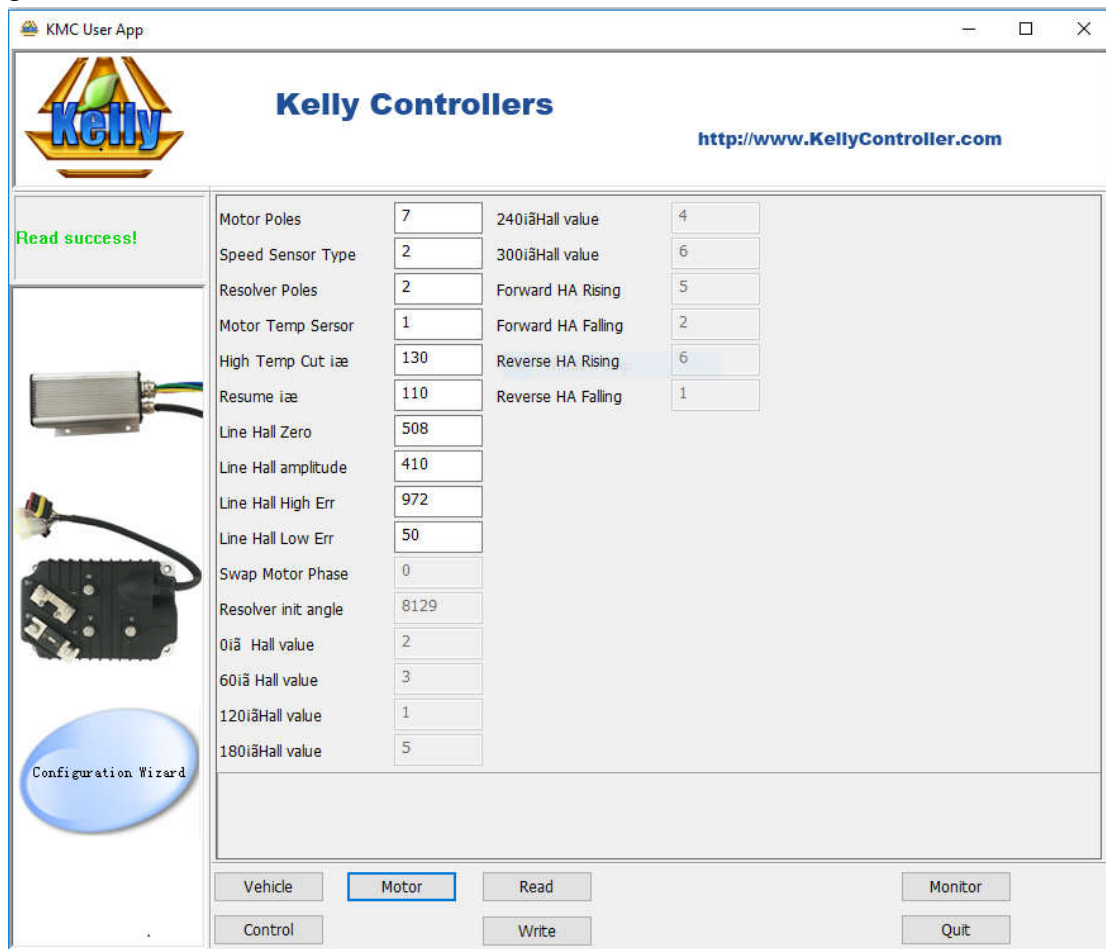

So output range of Sin/Cosin speed sensor is $3 - 1.1\text{V} = 1.9\text{V}$ to $3 + 1.1\text{V} = 4.1\text{V}$. ($1.9\text{V} - 4.1\text{V}$).

We set the Line hall high err at 972. It is about 4.75V. The line hall low err at 50. It is about 0.25V. So as long as the output is in the range from 0.25V to 4.6V. It should be good. The controller will not report hall error code in this case. We need to go to Step 5 to do the identification angle operation directly. If the identification angle operation is finished successfully, there is no problem. The line hall zero and amplitude values are correct. Otherwise we need to measure the line hall zero point and hall amplitude by manual.

Because the previous value is just from the calculation in theory. We think the 5V could be a little lower than 5V. There is 5% deflection for 5V source and 2% deflection for hall amplitude.

Here is the solution.

1), So please make sure the sensor connector is connected between controller and motor. Then please measure the output of Sin or Cosin output when you rotate the motor manually and slowly. Please let us know the min and max output of this port.

2), Then please calculate the value. $\text{Zero-Crossing point} = (V_{\min} + V_{\max}) / 2$.

$\text{Amplitude} = \text{Zero-crossing point} - V_{\min} = V_{\max} - \text{Zero-Crossing point}$.

3), Then we need to fill the correct Zero-crossing point and Amplitude again.

Please make sure the 5V is from the controller for Sin/Cosin sensor.

We need to click Write button in the user program each time when you change the settings. And we need to do identification angle operation each time after you changed the settings. We need to reset the power supply each time when we change the settings and do the identification angle operation.

We may wait a few seconds to reset the power supply after change the settings.

5, Please fill 170 in the identification angle item. And please click the write button. The user program will give a pop-up window which show the Write operation is successful. Please quit from the user program. Please turn off the power supply.

6, Please turn on the power supply after the power supply is off for a few seconds. The motor shaft will try to run on directions randomly. It is normal because the controller is doing Identification angle operation.

7, Please wait about 2-3 minutes.

8, If the identification angle operation is finished, the motor will stop completely. And you will see reset error message in the monitor screen of user program. You can see the error message in monitor screen of user program for KLS-8080I controller also.

9, Please turn off the power supply again. Please wait about a few seconds to turn on the power supply one more time.

10, Please try to connect the controller to user program again. You will see 85 in the identification angle item. That is to say, the controller identification angle operation is successful. You can use the KLS-8080IPS controller to drive the motor now.

11, As long as it is not reset error code, the value in identification angle will not go back to 85. The value is always at 170. That is to say, the controller is still in the processing of identification operation.

12, Please don't try to write 85 in the identification angle or reset the power supply if you don't see any error codes.

13, If the constant beep sound lasts above 5 minutes and there are other error codes such as Identify error, hall err etc, please return to the first picture of user program. Please write 85

instead in identification angle by manual.

If there are no any error codes,you can not write it back to 85 by manual.Please wait longer time until the error codes occur.

Please don't keep 170 in the identification angle item when you want to turn off the power supply.

Otherwise the controller will try to keep doing identification operation all the time as long as you turn on power supply again.

When the error codes occur,please quit from user program.Please try again from step 6.

14,Please don't keep 170 in identification angle item before power supply is turned on after the identification operation is successful.

15,If the direction of the motor is not what you expected,please don't try to do Identification angle operation again.You just need to enable Change Direction item in the first picture of user program.Please click Write Button and reset the power supply to activate the setting.Then the motor will run on the expected direction.

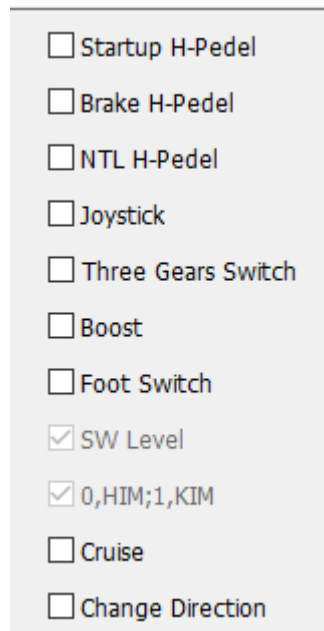

A screenshot of a settings menu with the following options:

- Startup H-Pedel
- Brake H-Pedel
- NTL H-Pedel
- Joystick
- Three Gears Switch
- Boost
- Foot Switch
- SW Level
- 0,HIM;1,KIM
- Cruise
- Change Direction

Another way to calculate the line hall zero point and line hall amplitude is please try to download Sin/Cosin monitor software from our website.Please rotate the motor shaft by manual for a few cycles.Then please record the min and max value of either of Ha or Hb.Here is the formula to calculate the line hall zero point and amplitude.

Zero point= $1023 * ((\text{Min} + \text{Max}) / 2) / 255$

Amplitude= $1023 * (\text{Max} - (\text{Min} + \text{Max}) / 2) / 255$

Chapter 5 Maintenance

There are no user-serviceable parts inside the controllers. Do not attempt to open the controller as this will void your warranty. However, periodic, exterior cleaning of the controller

should be carried out.

The controller is a high powered device. When working with any battery powered vehicle, proper safety precautions should be taken that include, but are not limited to, proper training, wearing eye protection, avoidance of loose clothing, hair and jewelry. Always use insulated tools.

5.1 Cleaning

Although the controller requires virtually no maintenance after properly installation, the following minor maintenance is recommended in certain applications.

- Remove power by disconnecting the battery, starting with battery positive.
- Discharge the capacitors in the controller by connecting a load (such as a contactor coil, resistor or a horn) across the controller's B+ and B- terminals.
- Remove any dirt or corrosion from the bus bar area. The controller should be wiped with a moist rag. Make sure that the controller is dry before reconnecting the battery.
- Make sure the connections to the bus bars, if fitted are tight. To avoid physically stressing the bus bars use two, well-insulated wrenches.

5.2 Configuration

You can configure the controller with a host computer through either an RS232 or USB port.

- Disconnect motor wiring from controller for configuring existing parameters in the user program or Android APP. If this operation is too much extra job for you, please make sure the motor must be stopped before programming.
- The controller may display fault code, but it doesn't affect programming or configuration. But it will affect the Identification angle operation. Please try to eliminate the error codes before Identification angle operation.
- Use a straight through RS232 cable or USB converter provided by Kelly to connect to a host computer. Provide >+18V to PWR (for a 24V controller, provide >+8V) . Wire power supply return (supply negative) to any RTN pin.
- KLS controller requires a 4pin connector to Kelly RS232 Converter to support the communication. And customers may need a Z-TEK USB cable for Tablet with Android OS.

Customers may download PC software or Android APP to program the controller before running the motor. You may do Identification angle for brushless motor with hall sensors after running the software or Android APP. Every item in the configuration program can show the explanation automatically when you click it.

Caution:

- **Make certain that the motor is connected before trying to run Identification angle function in the configuration software. The controller needs to be connected to batteries, motor and throttle before Identification operation. That is to say, it is not enough to connect only power supply (PWR=pin7) to batteries for**

Identification Angle operation.

- Configuration software will be regularly updated and published on the website. Please Update your Configuration Software regularly. You must uninstall the older version before updating.
- Please try to use Identify function for motor and hall sensors in the user program

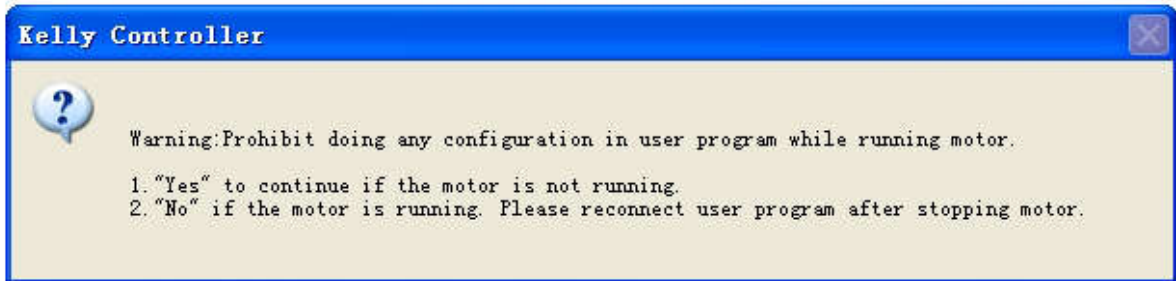

Table 1: ERROR CODES

Buzzer Error Codes

Code	Explanation	Solution
1,1 □ □	Automatic error identification	1. Wrong wiring of motor phase line or hall. Please suspend the motor when enable Auto-Identify function.
1,2 □ □□	Over voltage error	2. Battery voltage is too high for the controller. Check battery volts and configuration. 3. Regeneration over-voltage. Controller will have cut back or stopped regen. 4. This only accurate to ± 2% upon Overvoltage setting.
1,3 □ □□□	Low voltage error	1. The controller will clear after 5 seconds if battery volts returns to normal. 2. Check battery volts & recharge if required.
1,4 □ □□□□	Reserved	
2,1 □□ □	Motor did not start	Motor did not reach 25 electrical RPM within 2 seconds of start-up. Hall sensor or phase wiring problem.
2,2 □□ □□	Internal volts fault	1. Measure that B+ & PWR are correct when measured to B- or RTN. 2. There may be excessive load on the +5V supply caused by too low a value of Regen or throttle potentiometers or incorrect wiring. 3. Controller is damaged. Contact Kelly about a warranty repair.
2,3 □□ □□□	Over temperature	The controller temperature has exceeded 100°C. The

			controller will be stopped but will restart when temperature falls below 80°C.
2,4	00 0000	Throttle error at power-up	Throttle signal is higher than the preset 'dead zone' at Power On. Fault clears when throttle is released.
3,1	000 0	Reserved	
3,2	000 00	Internal reset	May be caused by some transient fault condition like a temporary over-current, momentarily high or low battery voltage. This can happen during normal operation.
3,3	000 000	Hall throttle is open or short-circuit	When the throttle is repaired, a restart will clear the fault.
3,4	000 0000	Angle sensor error	1.Speed sensor type error, customers may set the correct sensor type through user program or App. Please download how to use Identification function instruction from our website. 2.Incorrect wiring. 3.Speed sensor is damaged or defective.Or feedback signal is erratic.
4,1	0000 0	Reserved	
4, 2	0000 00	Reserved	
4, 3	0000 000	Motor over-temperature	Motor temperature has exceeded the configured maximum. The controller will shut down until the motor temperature cools down.
4, 4	0000 0000	Hall Galvanometer sensor error	1.Hall galvanometer device is damaged inside the controller. This error code is only valid for KLS-8080I/IPS controller.
Customers may read error codes in PC software or Android Tablet			

Contact Us:

Kelly Controls

Home Page:

<http://www.KellyController.com>

Download user manual,instructions and user program:

www.kellycontroller.com/support.php

E-mail:

Sales@Kelly-Controls.com

Phone:

(01) 224 637 5092